

SUPPLIER ASSESSMENT REPORT

-- Follow Up Audit

Report Number: QIP-ASR134841

This report is issued by Focus Technology Co., Ltd. (Made-in-China.com) and the supervising inspectorate (SGS-CSTC Standards Technical Services Co., Ltd.) to confirm that:

Company Name : Jiangyin Yangzi Fitting Co., Ltd.
 江阴市扬子管件有限公司

Showroom : <http://yangzi001.en.made-in-china.com>

Address : No. 168, Panlongshan Road, Shanguan Town, Jiangyin, Wuxi, Jiangsu, China

Product : Pipe fitting, Pipe reducer, Pipe cap, Elbow, Tee & Cross, Lap joint stub end, etc.

Follow Up Audit Date	05 Jun., 2013	Expiry Date	04 Jun., 2014
Auditor	Simon Gao	Reviewed by	Roger Wang

Follow Up Audit is annual review for the company and the Scope:

1. General Information
2. Production Capacity
3. Photos

This report is annual follow up audit for the initial audit report: Initial Audit is audited on 23 May, 2012 and the Scope:

1. General Information
2. Foreign Trade Capacity
3. Management System and Product Certification
4. Production Capacity & Quality Control
5. Photos



The initial report is also attached
General Comments:

Jiangyin Yangzi Fitting Co., Ltd. is a manufacturer with 108 employees; it was established in 1989, located in No. 168, Panlongshan Road, Shanguan Town, Jiangyin, Wuxi, Jiangsu, China. The buildings occupy an area of more than 10,400 square meters.



Sign for and on behalf of
 SGS-CSTC Standards Technical Services Co., Ltd.

This document is issued by the Company under its General Conditions of Service accessible at http://www.sgs.com/terms_and_conditions.htm. Attention is drawn to the limitation of liability, indemnification and jurisdiction issues defined therein. Any holder of this document is advised that information contained hereon is solely limited to visual examination of the safely and readily accessible portions of the consignment and reflects the Company's findings at the time of its intervention only and within the limits of Client's instructions, if any. The Company's sole responsibility is to its Client and this document does not exonerate parties to a transaction from exercising all their rights and obligations under the transaction documents. Any unauthorized alteration, forgery or falsification of the content or appearance of this document is unlawful and offenders may be prosecuted to the fullest extent of the law.

Attention: To check the authenticity of testing /inspection report & certificate, please contact us at telephone: (86-755)83071443, or email: CN.Doccheck@sgs.com

Page No.: 1 of 20



FOLLOW UP AUDIT REPORT

Audited Company	Jiangyin Yangzi Fitting Co., Ltd. 江阴市扬子管件有限公司
Audited Site:	No. 168, Panlongshan Road, Shanguan Town, Jiangyin, Wuxi, Jiangsu, China

Consigner of Assessment	Made-in-China.com		
Audit Type	Follow up audit		
Valid Date	From 05 Jun., 2013 to 04 Jun., 2014	Verify Report	www.sgs.com
Auditor	Simon Gao	Reviewed by	Roger Wang

CONTENTS

- Part A: General Information**
 - Section 1: Company Overview
 - Section 2: Human Resources
- Part B: Foreign Trade Capacity**
 - Section 1: Export Overall Situation
 - Section 2: Export Business Capacity
- Part C: Production Capacity**
 - Section 1: Production Capacity
- Part D: Photos**
 - Section 1: Photos of Documents
 - Section 2: Photos of Company

This document is issued by the Company under its General Conditions of Service accessible at http://www.sgs.com/terms_and_conditions.htm. Attention is drawn to the limitation of liability, indemnification and jurisdiction issues defined therein. Any holder of this document is advised that information contained hereon is solely limited to visual examination of the safely and readily accessible portions of the consignment and reflects the Company's findings at the time of its intervention only and within the limits of Client's instructions, if any. The Company's sole responsibility is to its Client and this document does not exonerate parties to a transaction from exercising all their rights and obligations under the transaction documents. Any unauthorized alteration, forgery or falsification of the content or appearance of this document is unlawful and offenders may be prosecuted to the fullest extent of the law.

Attention: To check the authenticity of testing /inspection report & certificate, please contact us at telephone: (86-755)83071443, or email: CN.Doccheck@sgs.com



Part A: General Information

Section 1: Company Overview

1.1 Legal Validity			
Does the company have a valid business license?	<input checked="" type="checkbox"/> Yes <input type="checkbox"/> No <input type="checkbox"/> Others	Registration Number	320281000079439
Year of established	17 Aug., 1989	Valid Date	08 Aug., 2022
Registered address	No. 168, Panlongshan Road, Shangguan Town, Chengdong Street, Jiangyin, Wuxi, Jiangsu, China		
Actual address	No. 168, Panlongshan Road, Shangguan Town, Jiangyin, Wuxi, Jiangsu, China		
Is the annual review done by local authority (Industrial & Commercial Bureau)?	The business was reviewed in the year of 2013.		
Registered capital	RMB 12,000,000		
Paid-in capital	RMB 12,000,000		
Name of legal representative	Mr. Guochen Zhang		
Business scope	Special item: None Normal item: Manufacturing and processing of pipe fitting, chemical machinery, alloy casting and hardware; Self-management and agency all kinds of goods and technology import and export business (except the state limited enterprise management or prohibit) (special items according to permit license)		
1.2 Basic Information			
Contact person	Ms. Cynthia Feng	Email	cynthiafeng2006@gmail.com
Phone number	0086-510-86996585-8000	Fax number	0086-510-86992666
URL/Web address	www.yzpipe.com/eng/index.asp		
Company type	<input checked="" type="checkbox"/> Manufacturer <input type="checkbox"/> Trading Company <input type="checkbox"/> Combined <input type="checkbox"/> Group Corporation		
Type of ownership	<input checked="" type="checkbox"/> Limited Company <input type="checkbox"/> Public Company <input type="checkbox"/> Foreign joint venture <input type="checkbox"/> State-Owned <input type="checkbox"/> Private Owner <input type="checkbox"/> Wholly foreign-owned enterprises		
Subsidiary company	No subsidiary company		
Products manufactured / sold scope	Pipe fitting, Pipe reducer, Pipe cap, Elbow, Tee & Cross, Lap joint stub end, etc.		
1.3 Company Building Information			
According to:			
<input checked="" type="checkbox"/> Land certificate <input checked="" type="checkbox"/> Real estate certificate <input type="checkbox"/> Lease agreement <input type="checkbox"/> Observation Estimated on site			
The company area 10,468.04 square meters The land occupies 16,615 square meters. The offices occupy 2,715.33 square meters. The workshops occupy 7,752.71 square meters.			

This document is issued by the Company under its General Conditions of Service accessible at http://www.sgs.com/terms_and_conditions.htm. Attention is drawn to the limitation of liability, indemnification and jurisdiction issues defined therein. Any holder of this document is advised that information contained hereon is solely limited to visual examination of the safely and readily accessible portions of the consignment and reflects the Company's findings at the time of its intervention only and within the limits of Client's instructions, if any. The Company's sole responsibility is to its Client and this document does not exonerate parties to a transaction from exercising all their rights and obligations under the transaction documents. Any unauthorized alteration, forgery or falsification of the content or appearance of this document is unlawful and offenders may be prosecuted to the fullest extent of the law.

Attention: To check the authenticity of testing /inspection report & certificate, please contact us at telephone: (86-755)83071443, or email: CN.Doccheck@sgs.com

Page No.: 3 of 20



Section 2: Human Resources

2.1 Company Chart

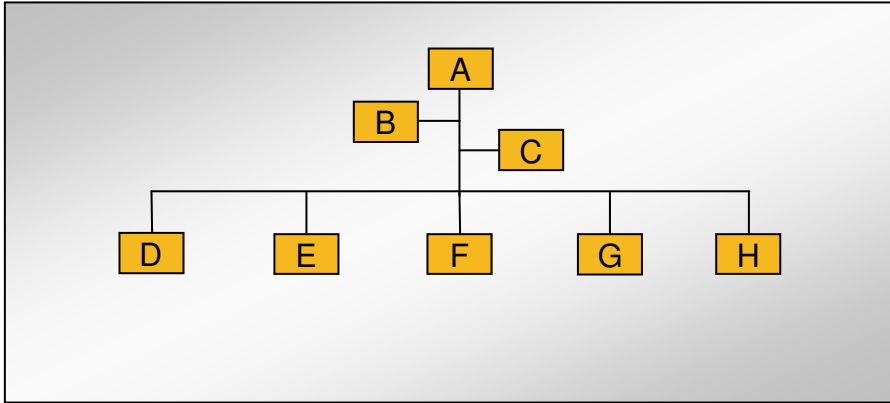

2.2 Explanation of Code and Employee Details

Code	Department	Number of employees
A	General Manager	1
B	Vice General Manager	1
C	Technology Director	1
D	Admin Dept.	6
E	R & D Dept.	8
F	Financial Dept.	2
G	Sales Dept.	8
H	Production Dept.	81
Number in total:		108

This document is issued by the Company under its General Conditions of Service accessible at http://www.sgs.com/terms_and_conditions.htm. Attention is drawn to the limitation of liability, indemnification and jurisdiction issues defined therein. Any holder of this document is advised that information contained hereon is solely limited to visual examination of the safely and readily accessible portions of the consignment and reflects the Company's findings at the time of its intervention only and within the limits of Client's instructions, if any. The Company's sole responsibility is to its Client and this document does not exonerate parties to a transaction from exercising all their rights and obligations under the transaction documents. Any unauthorized alteration, forgery or falsification of the content or appearance of this document is unlawful and offenders may be prosecuted to the fullest extent of the law.

Attention: To check the authenticity of testing /inspection report & certificate, please contact us at telephone: (86-755)83071443, or email: CN.Doccheck@sgs.com



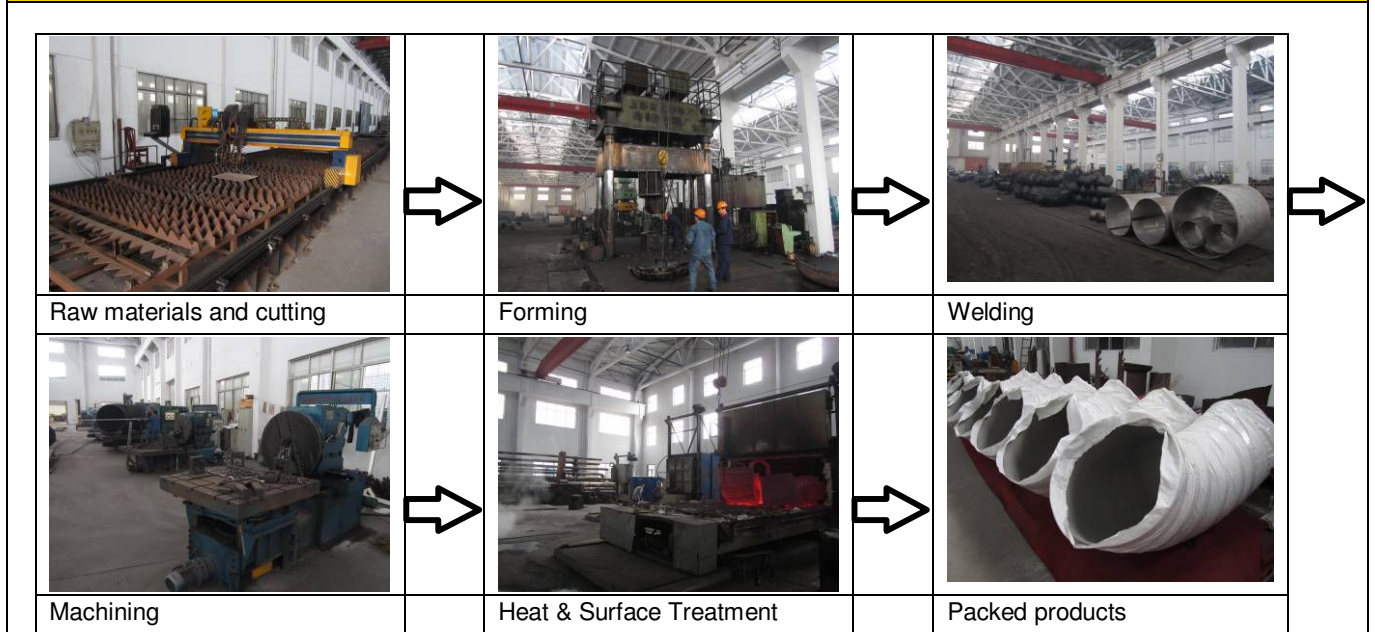

Part C: Production Capacity

Section 1: Production Capacity

1.1 Production Workflow Chart







1.2 Main Facilities

Picture	Facility name	Brand or Country/Region of origin	Target Value/machine*day	Quantity
	Pressure forming machine	China	N/A	3
	Cold forming machine	China	N/A	6
	Pipe machining tool	China	N/A	3
	Welding machine	China	N/A	2

This document is issued by the Company under its General Conditions of Service accessible at http://www.sgs.com/terms_and_conditions.htm. Attention is drawn to the limitation of liability, indemnification and jurisdiction issues defined therein. Any holder of this document is advised that information contained hereon is solely limited to visual examination of the safely and readily accessible portions of the consignment and reflects the Company's findings at the time of its intervention only and within the limits of Client's instructions, if any. The Company's sole responsibility is to its Client and this document does not exonerate parties to a transaction from exercising all their rights and obligations under the transaction documents. Any unauthorized alteration, forgery or falsification of the content or appearance of this document is unlawful and offenders may be prosecuted to the fullest extent of the law.

Attention: To check the authenticity of testing /inspection report & certificate, please contact us at telephone: (86-755)83071443, or email: CN.Doccheck@sgs.com



	Heat treatment furnace	China	N/A	4
	Pickling workshop	China	N/A	1
	Sawing machine	China	N/A	2
	Lathe (various models)	China	N/A	4

This document is issued by the Company under its General Conditions of Service accessible at http://www.sgs.com/terms_and_conditions.htm. Attention is drawn to the limitation of liability, indemnification and jurisdiction issues defined therein. Any holder of this document is advised that information contained hereon is solely limited to visual examination of the safely and readily accessible portions of the consignment and reflects the Company's findings at the time of its intervention only and within the limits of Client's instructions, if any. The Company's sole responsibility is to its Client and this document does not exonerate parties to a transaction from exercising all their rights and obligations under the transaction documents. Any unauthorized alteration, forgery or falsification of the content or appearance of this document is unlawful and offenders may be prosecuted to the fullest extent of the law.

Attention: To check the authenticity of testing /inspection report & certificate, please contact us at telephone: (86-755)83071443, or email: CN.Doccheck@sgs.com



Part D: Photos

Section 1: Photos of Documents

1.1 Photos of Documents

Description: Business License



Description: Land Certificate



Description: Real Estate Certificate

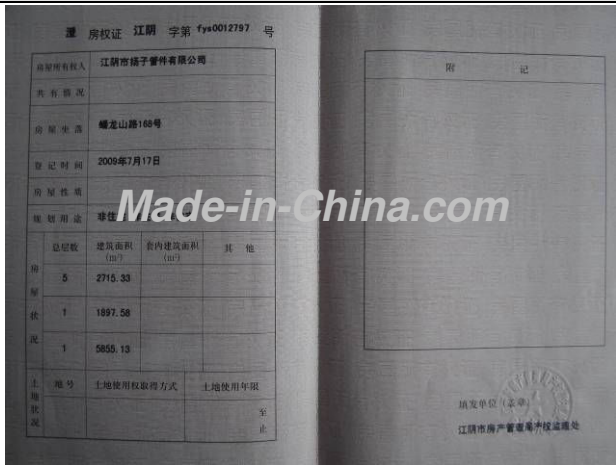

This document is issued by the Company under its General Conditions of Service accessible at http://www.sgs.com/terms_and_conditions.htm. Attention is drawn to the limitation of liability, indemnification and jurisdiction issues defined therein. Any holder of this document is advised that information contained hereon is solely limited to visual examination of the safely and readily accessible portions of the consignment and reflects the Company's findings at the time of its intervention only and within the limits of Client's instructions, if any. The Company's sole responsibility is to its Client and this document does not exonerate parties to a transaction from exercising all their rights and obligations under the transaction documents. Any unauthorized alteration, forgery or falsification of the content or appearance of this document is unlawful and offenders may be prosecuted to the fullest extent of the law.

Attention: To check the authenticity of testing /inspection report & certificate, please contact us at telephone: (86-755)83071443, or email: CN.Doccheck@sgs.com

Section 2: Photos of Company

2.1 Photos of Company and Product Sample

Description: Company Gate



Description: Office Building



Description: Workshop Building



Description: Workshop



Description: Workshop



Description: Workshop



This document is issued by the Company under its General Conditions of Service accessible at http://www.sgs.com/terms_and_conditions.htm. Attention is drawn to the limitation of liability, indemnification and jurisdiction issues defined therein. Any holder of this document is advised that information contained hereon is solely limited to visual examination of the safely and readily accessible portions of the consignment and reflects the Company's findings at the time of its intervention only and within the limits of Client's instructions, if any. The Company's sole responsibility is to its Client and this document does not exonerate parties to a transaction from exercising all their rights and obligations under the transaction documents. Any unauthorized alteration, forgery or falsification of the content or appearance of this document is unlawful and offenders may be prosecuted to the fullest extent of the law.

Attention: To check the authenticity of testing /inspection report & certificate, please contact us at telephone: (86-755)83071443, or email: CN.Doccheck@sgs.com

Description: Workshop



Description: Workshop



Description: Test Instrument



Description: Test Instruments



Description: Test Instruments



Description: Test Instruments



-- End of the Follow up Audit Report --

This document is issued by the Company under its General Conditions of Service accessible at http://www.sgs.com/terms_and_conditions.htm. Attention is drawn to the limitation of liability, indemnification and jurisdiction issues defined therein. Any holder of this document is advised that information contained hereon is solely limited to visual examination of the safely and readily accessible portions of the consignment and reflects the Company's findings at the time of its intervention only and within the limits of Client's instructions, if any. The Company's sole responsibility is to its Client and this document does not exonerate parties to a transaction from exercising all their rights and obligations under the transaction documents. Any unauthorized alteration, forgery or falsification of the content or appearance of this document is unlawful and offenders may be prosecuted to the fullest extent of the law.

Attention: To check the authenticity of testing /inspection report & certificate, please contact us at telephone: (86-755)83071443, or email: CN.Doccheck@sgs.com

Initial Audit Report

Audited Company	Jiangyin Yangzi Fitting Co., Ltd. 江阴市扬子管件有限公司
Audited Site:	No. 168, Panlongshan Rd., Shangguan Town, Jiangyin, Wuxi, Jiangsu, China
Representative of Audited Company:	Ms. Zhang Yafang / Financial Dept.

Consigner of Assessment	Made-in-China.com		
Audit Type	<input type="checkbox"/> Initial Audit <input checked="" type="checkbox"/> Re-audit		
Valid Date	From 23 May, 2012 to 22 May, 2013	Verify Report	www.sgs.com
Auditor	Kain Qian	Reviewed by	Roger Wang

CONTENTS

- Part A: General Information**
 - Section 1: Company Overview
 - Section 2: Human Resources
- Part B: Foreign Trade Capacity**
 - Section 1: Export Overall Situation
 - Section 2: Export Business Capacity
 - Section 3: Supplier Management
 - Section 4: After-sales Service Capacity
- Part C: Product Research & Development Capacity**
 - Section 1: Product Research & Development Capacity
- Part D: Quality Management System and Product Certification**
 - Section 1: Quality Management System(s) and Product Certification
- Part E: Production Capacity & Quality Control**
 - Section 1: Production Capacity Section
 - Section 2: Production Process Control
 - Section 3: Company Development / Expansion Plan
- Part F: Financial Position**
 - Section 1: Financial Data
 - Section 2: Key Performance Indications
 - Section 3: Banking
 - Section 4: Product Insurance
- Part G: Working Environment & Energy Saving**
 - Section 1: Working Environment
 - Section 2: Energy Savings and Emission Reduction
- Part H: Photos**
 - Section 1: Photos of Documents
 - Section 2: Photos of Company

This document is issued by the Company under its General Conditions of Service accessible at http://www.sgs.com/terms_and_conditions.htm. Attention is drawn to the limitation of liability, indemnification and jurisdiction issues defined therein. Any holder of this document is advised that information contained hereon is solely limited to visual examination of the safely and readily accessible portions of the consignment and reflects the Company's findings at the time of its intervention only and within the limits of Client's instructions, if any. The Company's sole responsibility is to its Client and this document does not exonerate parties to a transaction from exercising all their rights and obligations under the transaction documents. Any unauthorized alteration, forgery or falsification of the content or appearance of this document is unlawful and offenders may be prosecuted to the fullest extent of the law.

Attention: To check the authenticity of testing /inspection report & certificate, please contact us at telephone: (86-755)83071443, or email: CN.Doccheck@sgs.com

Page No.: 10 of 20



Part A: General Information

Section 1: Company Overview

1.1 Legal Validity			
Does the company have a valid business license?	<input checked="" type="checkbox"/> Yes <input type="checkbox"/> No <input type="checkbox"/> Others	Registration Number	No.: 320281000079439
Year of established	17 Aug., 1989	Valid Date	08 Aug., 2022
Registered address	No. 168, Panlongshan Rd., Shanguan Town, Jiangyin, Wuxi, Jiangsu, China		
Actual address	No. 168, Panlongshan Rd., Shanguan Town, Jiangyin, Wuxi, Jiangsu, China		
Is the annual review done by local authority (Industrial & Commercial Bureau)?	The business license was reviewed in 2012.		
Registered capital	RMB 12 million		
Name of legal representative	Mr. Zhang Guochen		
Business scope	Special item: none Normal item: manufacture and processing for pipe fitting, chemical machinery, alloy casting and hardware. All kinds of product and technology import & export business, except the forbidden project by government. (If above scope relate with approval, need license).		
1.2 Basic Information			
Contact person	Ms. Cynthia Feng / Export Manager	Email	cynthiafeng2006@gmail.com
Phone number	0086-510-86996586-8000	Fax number	0086-510-86992666
URL/Web address	www.yzpipe.com		
Company type	<input checked="" type="checkbox"/> Manufacturer <input type="checkbox"/> Foreign trader		
Type of ownership	<input checked="" type="checkbox"/> Limited Company <input type="checkbox"/> Public Company <input type="checkbox"/> Joint Venture <input type="checkbox"/> State-Owned <input type="checkbox"/> Private Owner <input type="checkbox"/> Wholly foreign-owned enterprises		
Subsidiary company	No subsidiary company		
Products manufactured / sold scope	Pipe fitting, Reducer, Elbow, Tee, Cross, Cap, Lap joint stub end		
1.3 Company Building Information			
According to:	<input checked="" type="checkbox"/> Land certificate <input type="checkbox"/> Real estate certificate <input type="checkbox"/> Lease agreement		
The land occupies 16,615 square meters.			

This document is issued by the Company under its General Conditions of Service accessible at http://www.sgs.com/terms_and_conditions.htm. Attention is drawn to the limitation of liability, indemnification and jurisdiction issues defined therein. Any holder of this document is advised that information contained hereon is solely limited to visual examination of the safely and readily accessible portions of the consignment and reflects the Company's findings at the time of its intervention only and within the limits of Client's instructions, if any. The Company's sole responsibility is to its Client and this document does not exonerate parties to a transaction from exercising all their rights and obligations under the transaction documents. Any unauthorized alteration, forgery or falsification of the content or appearance of this document is unlawful and offenders may be prosecuted to the fullest extent of the law.

Attention: To check the authenticity of testing / inspection report & certificate, please contact us at telephone: (86-755)83071443, or email: CN.Doccheck@sgs.com

Page No.: 11 of 20



Section 2: Human Resources

2.1 Company Chart

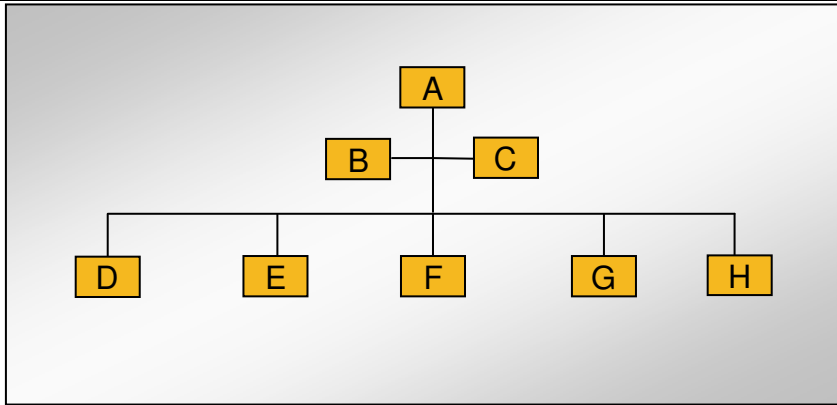

2.2 Explanation of Code and Employee Details

Code	Department	Number of employees
A	General Manager	1
B	Vice General Manager	1
C	Technology Director	1
D	Admin Dept.	6
E	R&D Dept.	5
F	Production Dept.	68
G	Financial Dept.	2
H	Sales Dept.	5
Number in total:		89

Remark: The number of employees was based on staff list of May, 2011.

2.3 Key Staff

Title	Full name	Education	Working experience for this trade / total experience
General Manager	Mr. Zhang Guochen	/	Over 40 years

Remark: Above information of key staff was based on interview with company representative.

This document is issued by the Company under its General Conditions of Service accessible at http://www.sgs.com/terms_and_conditions.htm. Attention is drawn to the limitation of liability, indemnification and jurisdiction issues defined therein. Any holder of this document is advised that information contained hereon is solely limited to visual examination of the safety and readily accessible portions of the consignment and reflects the Company's findings at the time of its intervention only and within the limits of Client's instructions, if any. The Company's sole responsibility is to its Client and this document does not exonerate parties to a transaction from exercising all their rights and obligations under the transaction documents. Any unauthorized alteration, forgery or falsification of the content or appearance of this document is unlawful and offenders may be prosecuted to the fullest extent of the law.

Attention: To check the authenticity of testing / inspection report & certificate, please contact us at telephone: (86-755)83071443, or email: CN.Doccheck@sgs.com



Part B: Foreign Trade Capacity

Section 1: Export Overall Situation

1.1 Export Overall Situation	
Does the company have a valid export license?	<input checked="" type="checkbox"/> Yes <input type="checkbox"/> No
The import and export enterprise code.	3200142210943
The number of foreign trading staff with relevant trading experience.	<input type="checkbox"/> within 1 year staff <input checked="" type="checkbox"/> 1-5 years 1 staff <input checked="" type="checkbox"/> 5-10 years 1 staff <input type="checkbox"/> over 10 years staff Total 2 staffs
The language freely used by foreign trade staff	<input checked="" type="checkbox"/> English <input type="checkbox"/> others
Annual revenue of previous year	Refer to relevant financial report; the annual revenue was over RMB 41 million in 2011.
Annual export revenue of previous year	Company's foreign trade business was started from 2012.
Estimated export revenue for this year.	Company's foreign trade business was started from 2012.
Overseas agent	No overseas agent
Nearest port	Shanghai Port
Acceptable quotation	<input checked="" type="checkbox"/> FOB <input checked="" type="checkbox"/> CIF
Acceptable payment type	<input checked="" type="checkbox"/> LC <input checked="" type="checkbox"/> T/T
What is the company's projected average lead time from PO confirmation to production EX works delivery?	Around 20~40 workdays

Section 2: Export Business Capacity

2.1 Market Distribution (please list top three areas)		
Market	Main Product	% of Total Business Volume (last year)
N/A	N/A	N/A

Remark: Company's foreign trade business was started from 2012. Refer to relevant documentation; they had foreign trade business in Germany.

This document is issued by the Company under its General Conditions of Service accessible at http://www.sgs.com/terms_and_conditions.htm. Attention is drawn to the limitation of liability, indemnification and jurisdiction issues defined therein. Any holder of this document is advised that information contained hereon is solely limited to visual examination of the safely and readily accessible portions of the consignment and reflects the Company's findings at the time of its intervention only and within the limits of Client's instructions, if any. The Company's sole responsibility is to its Client and this document does not exonerate parties to a transaction from exercising all their rights and obligations under the transaction documents. Any unauthorized alteration, forgery or falsification of the content or appearance of this document is unlawful and offenders may be prosecuted to the fullest extent of the law.

Attention: To check the authenticity of testing /inspection report & certificate, please contact us at telephone: (86-755)83071443, or email: CN.Doccheck@sgs.com

Page No.: 13 of 20



Section 3: Supplier Management

3.1 Supplier Management		
Item	Content	Observations /Comments
1	Does the company establish and implement an effective suppliers' assessment procedure?	<input checked="" type="checkbox"/> Have the written procedures and followed records <input type="checkbox"/> Have the written procedures but no records <input type="checkbox"/> Have relevant records without written procedure <input type="checkbox"/> No written procedures or followed records
2	Does the company have an updated list of approved suppliers?	<input type="checkbox"/> The approved suppliers list was updated in _____ <input checked="" type="checkbox"/> Have the written suppliers without approved signature or date. <input type="checkbox"/> Provided some suppliers names <input type="checkbox"/> No approved suppliers list

Section 4: After-sales Service Capacity

4.1 After-sales Service Capacity		
Item	Content	Observations /Comments
1	Is there a procedure to conduct random product inspection after final packaging in place?	<input type="checkbox"/> Have clear standards and written inspection records <input type="checkbox"/> No written standards but had inspection reports <input type="checkbox"/> Have the procedures but no inspection records <input checked="" type="checkbox"/> All inspection would be finished before packing except special requirement from clients.
2	Is there a clear procedure for handling customer complaints?	<input type="checkbox"/> Has the clear procedure and followed records <input checked="" type="checkbox"/> Has the procedure but no written records. <input type="checkbox"/> No written procedures or records.
3	Can the finished/package product be traced by lot identification to the appropriate raw materials test reports?	<input type="checkbox"/> Have the procedures to trace the raw materials. <input checked="" type="checkbox"/> Can trace main materials <input type="checkbox"/> Can trace production date. <input type="checkbox"/> Can't trace products
4	Are corrective & preventive actions mechanism established and implemented effectively (including the suppliers/ sub-contractors control, incoming inspection, process control, final inspection and customer complaint)?	<input checked="" type="checkbox"/> Has the clear procedure and followed records <input type="checkbox"/> Has the procedure but no written records. <input type="checkbox"/> No written procedures or records.

This document is issued by the Company under its General Conditions of Service accessible at http://www.sgs.com/terms_and_conditions.htm. Attention is drawn to the limitation of liability, indemnification and jurisdiction issues defined therein. Any holder of this document is advised that information contained hereon is solely limited to visual examination of the safely and readily accessible portions of the consignment and reflects the Company's findings at the time of its intervention only and within the limits of Client's instructions, if any. The Company's sole responsibility is to its Client and this document does not exonerate parties to a transaction from exercising all their rights and obligations under the transaction documents. Any unauthorized alteration, forgery or falsification of the content or appearance of this document is unlawful and offenders may be prosecuted to the fullest extent of the law.

Attention: To check the authenticity of testing /inspection report & certificate, please contact us at telephone: (86-755)83071443, or email: CN.Doccheck@sgs.com

Page No.: 14 of 20

Part D: Quality Management System and Product Certification

1.1 Quality Management System and Product Certification	
Has the company obtained a valid certificate for its quality management system? Such as ISO9001, QC080000 and etc.	ISO9001:2008 Certificate No.: 03509Q21734R3M Scope: production and service of butt-welded seamless pipe fitting steel plate butt-welded pipe fittings. Issued by XQCC Valid until 12 Nov., 2012
Is product certification done in terms of selling designation (UL for US, CCC for China, CE for Europe ...) at the company? I) Product certification list? if any II) Sample of product certification, if any (at least one of key products)? III) Copy of product certification sample (1-5 key products, if any)?	None

Part E: Production Capacity & Quality Control



Section 1: Production Capacity

1.1 Production Workflow Chart					
	→		→		
Cutting		Forming		Welding	
	→		→		
Machining		Surface treatment		Packed products	

This document is issued by the Company under its General Conditions of Service accessible at http://www.sgs.com/terms_and_conditions.htm. Attention is drawn to the limitation of liability, indemnification and jurisdiction issues defined therein. Any holder of this document is advised that information contained hereon is solely limited to visual examination of the safely and readily accessible portions of the consignment and reflects the Company's findings at the time of its intervention only and within the limits of Client's instructions, if any. The Company's sole responsibility is to its Client and this document does not exonerate parties to a transaction from exercising all their rights and obligations under the transaction documents. Any unauthorized alteration, forgery or falsification of the content or appearance of this document is unlawful and offenders may be prosecuted to the fullest extent of the law.



Attention: To check the authenticity of testing /inspection report & certificate, please contact us at telephone: (86-755)83071443, or email: CN.Doccheck@sgs.com

1.2 Products Situation (Top three Product Categories)

Product Category	Capacity in Top Month	Average Capacity	Total in 2011
 Description: Elbow	N/A	N/A	N/A
 Description: Tee	N/A	N/A	N/A

Remark: The company didn't allow publishing relevant details due to commercial secret.





1.3 Main Facilities

Picture	Facility name	Brand or Country/Region of origin	Quantity
	Cold Forming Machine	China	3
	Pressure Forming Machine	China	6
	Welding Machine	China	2

This document is issued by the Company under its General Conditions of Service accessible at http://www.sgs.com/terms_and_conditions.htm. Attention is drawn to the limitation of liability, indemnification and jurisdiction issues defined therein. Any holder of this document is advised that information contained hereon is solely limited to visual examination of the safely and readily accessible portions of the consignment and reflects the Company's findings at the time of its intervention only and within the limits of Client's instructions, if any. The Company's sole responsibility is to its Client and this document does not exonerate parties to a transaction from exercising all their rights and obligations under the transaction documents. Any unauthorized alteration, forgery or falsification of the content or appearance of this document is unlawful and offenders may be prosecuted to the fullest extent of the law.

Attention: To check the authenticity of testing /inspection report & certificate, please contact us at telephone: (86-755)83071443, or email: CN.Doccheck@sgs.com



	Pickling Pool	China	5
	Sand Blasting Room	China	2
	Heat Treatment Furnace	China	3
	Machine Tool	China	3
	Sawing Machine	China	1

This document is issued by the Company under its General Conditions of Service accessible at http://www.sgs.com/terms_and_conditions.htm. Attention is drawn to the limitation of liability, indemnification and jurisdiction issues defined therein. Any holder of this document is advised that information contained hereon is solely limited to visual examination of the safety and readily accessible portions of the consignment and reflects the Company's findings at the time of its intervention only and within the limits of Client's instructions, if any. The Company's sole responsibility is to its Client and this document does not exonerate parties to a transaction from exercising all their rights and obligations under the transaction documents. Any unauthorized alteration, forgery or falsification of the content or appearance of this document is unlawful and offenders may be prosecuted to the fullest extent of the law.

Attention: To check the authenticity of testing /inspection report & certificate, please contact us at telephone: (86-755)83071443, or email: CN.Doccheck@sgs.com



Section 2: Production Process Control

2.1 Production Process Control		
Item	Content	Observations /Comments
1	Are the environmental conditions, such as tidiness and cleanliness being controlled and suitable for the operation performed?	<input type="checkbox"/> Very tidy <input checked="" type="checkbox"/> Normal <input type="checkbox"/> Need to improve <input type="checkbox"/> Very poor
2	Are the necessary items /documents provided at appropriate location and under control?	<input type="checkbox"/> Work Instructions /procedures <input type="checkbox"/> Workmanship standard /acceptance <input type="checkbox"/> Golden sample /Approval sample <input checked="" type="checkbox"/> Product picture <input type="checkbox"/> Verbal by workshop director
3	Are written instructions available for incoming material inspections /testing? Is the relevant record maintained?	<input type="checkbox"/> Has instructions and uniformly followed <input type="checkbox"/> Has instruction but no written records <input checked="" type="checkbox"/> Materials checked by storage staff
4	Are written inspections /testing instructions available for finished products? Is the relevant record maintained?	<input type="checkbox"/> Have instructions and uniformly followed <input type="checkbox"/> Have instruction but no written records <input checked="" type="checkbox"/> Finished product checked by packing staff
5	What type of inspection is used for finished products?	<input type="checkbox"/> Random inspection <input type="checkbox"/> Visual inspection <input type="checkbox"/> Function inspection <input checked="" type="checkbox"/> 100% inspection <input checked="" type="checkbox"/> Visual inspection <input type="checkbox"/> Function inspection
6	Are non-conforming units clearly marked/ segregated to prevent accidental dispatch?	<input type="checkbox"/> Marked and segregated <input type="checkbox"/> Segregated but not marked clearly <input type="checkbox"/> Not found on site <input checked="" type="checkbox"/> All non-conforming units would be repaired on site directly
7	How are the non-conforming units handled?	<input checked="" type="checkbox"/> Repaired and re-inspection <input type="checkbox"/> Picked out <input type="checkbox"/> Used under control <input type="checkbox"/> Others

Section 3: Company Development / Expansion Plans

3.1 Company Development / Expansion Plans		
Item	Company Development Action(s)	Timeframe
1	N/A	N/A

This document is issued by the Company under its General Conditions of Service accessible at http://www.sgs.com/terms_and_conditions.htm. Attention is drawn to the limitation of liability, indemnification and jurisdiction issues defined therein. Any holder of this document is advised that information contained hereon is solely limited to visual examination of the safety and readily accessible portions of the consignment and reflects the Company's findings at the time of its intervention only and within the limits of Client's instructions, if any. The Company's sole responsibility is to its Client and this document does not exonerate parties to a transaction from exercising all their rights and obligations under the transaction documents. Any unauthorized alteration, forgery or falsification of the content or appearance of this document is unlawful and offenders may be prosecuted to the fullest extent of the law.

Attention: To check the authenticity of testing /inspection report & certificate, please contact us at telephone: (86-755)83071443, or email: CN.Doccheck@sgs.com





Part H: Photos

Section 1: Photos of Documents

1.1 Photos of Documents

Description: Business License

Description: Land Certificate

Description: Export License

Description: Custom Registration License

Description: ISO9001 Certificate

This document is issued by the Company under its General Conditions of Service accessible at http://www.sgs.com/terms_and_conditions.htm. Attention is drawn to the limitation of liability, indemnification and jurisdiction issues defined therein. Any holder of this document is advised that information contained hereon is solely limited to visual examination of the safely and readily accessible portions of the consignment and reflects the Company's findings at the time of its intervention only and within the limits of Client's instructions, if any. The Company's sole responsibility is to its Client and this document does not exonerate parties to a transaction from exercising all their rights and obligations under the transaction documents. Any unauthorized alteration, forgery or falsification of the content or appearance of this document is unlawful and offenders may be prosecuted to the fullest extent of the law.

Attention: To check the authenticity of testing /inspection report & certificate, please contact us at telephone: (86-755)83071443, or email: CN.Doccheck@sgs.com

Section 2: Photos of Company

2.1 Photos of Company and Product Sample

<p>Description: Company Gate</p>	<p>Description: Inside Factory</p>
<p>Description: Office</p>	<p>Description: Meeting Room</p>
<p>Description: Workshop</p>	<p>Description: Workshop</p>

-- End of the Report --

This document is issued by the Company under its General Conditions of Service accessible at http://www.sgs.com/terms_and_conditions.htm. Attention is drawn to the limitation of liability, indemnification and jurisdiction issues defined therein. Any holder of this document is advised that information contained hereon is solely limited to visual examination of the safely and readily accessible portions of the consignment and reflects the Company's findings at the time of its intervention only and within the limits of Client's instructions, if any. The Company's sole responsibility is to its Client and this document does not exonerate parties to a transaction from exercising all their rights and obligations under the transaction documents. Any unauthorized alteration, forgery or falsification of the content or appearance of this document is unlawful and offenders may be prosecuted to the fullest extent of the law.

Attention: To check the authenticity of testing /inspection report & certificate, please contact us at telephone: (86-755)83071443, or email: CN.Doccheck@sgs.com